

A



B

## DOT 14

The Dot Collection combines the directness of exposed, spherical bulbs with the rich materiality of brass. Focused, geometric compositions contain these two features, balancing line, surface, and luminous points. The result is a collection of lamps based in the reflectivity of brass—lamps that are both atmospheric and firm.

**type:** pendant

**construction:** brass body and hardware  
milk glass globes

**specifications:** source: LED lamp provided (G9 base)  
power consumption: (A,C) 20x3.5W; (B) 12 x 3.5W,  
lumen output: (A,C) 6010lm, (B) 3606lm  
colour temperature: 2700K included  
\* 3000K available upon request  
colour rendering index: 80 CRI standard  
\* ≥ 90 CRI upon request  
expected lifetime: ≥ 25 000h

**control:** refer to our recommended list of dimmer models

total height:	A,C	34"	40"	46"	52"	64"
		86cm	102 cm	117 cm	132 cm	163 cm
	B	24.5"	30.5"	36.5"	42.5"	54.5"
		62cm	77 cm	93 cm	108 cm	138 cm

**weight:** min. 5.5 lb / 2.5 kg

**certifications:**     IP20

**warranty:** 2 years

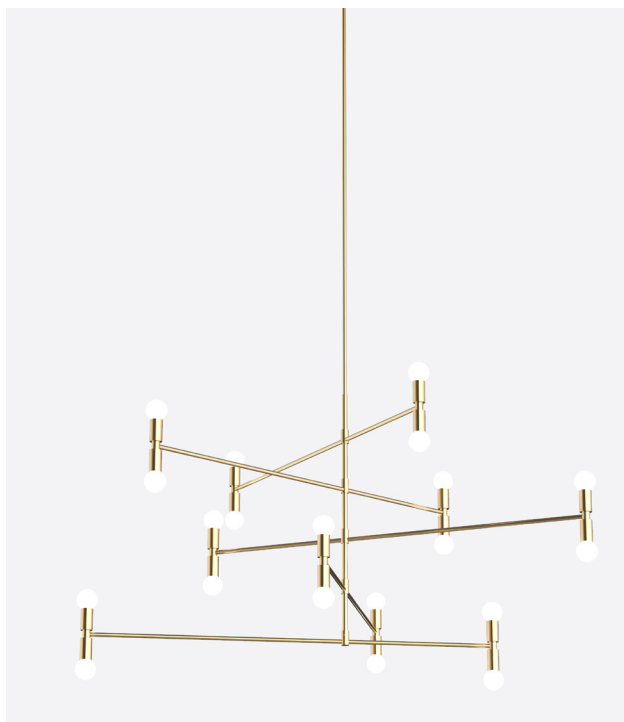

C

**A**

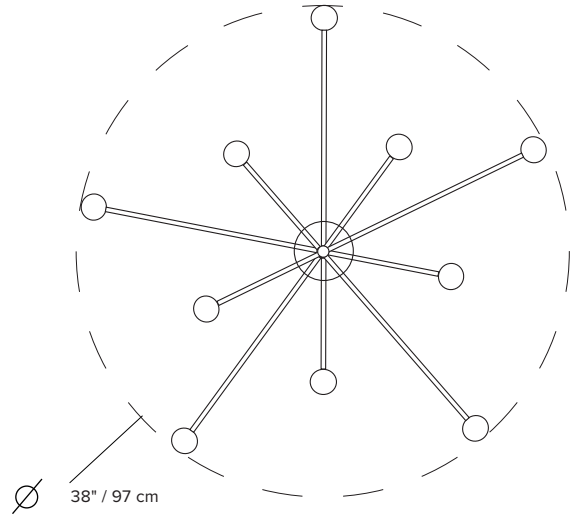
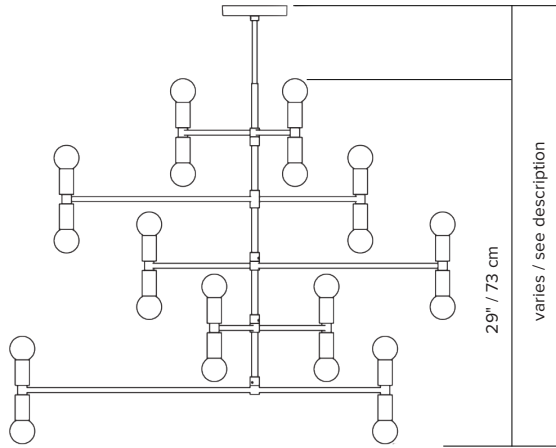

**B**

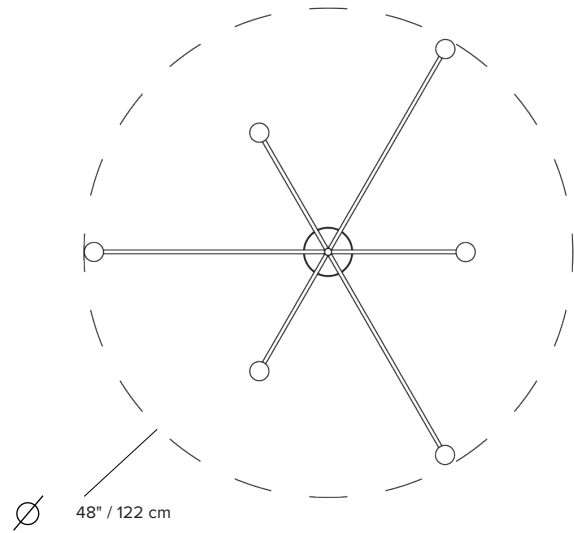
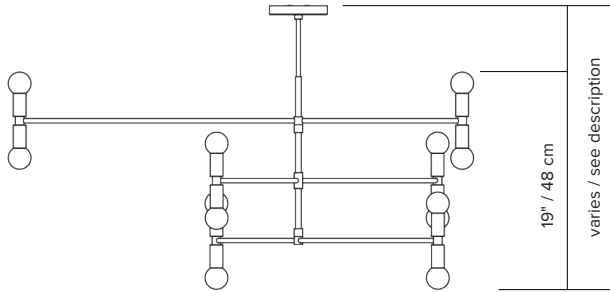

**C**

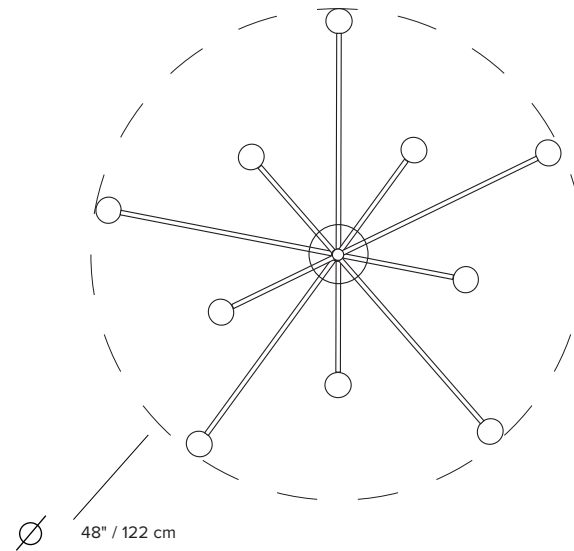
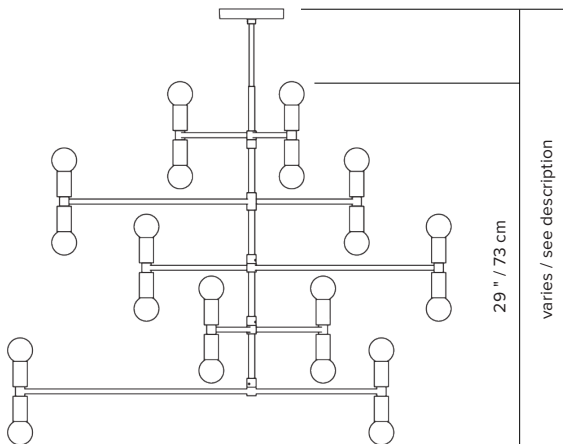

\*dimensions are approximate and may vary slightly

 G50 ∅ ±2" / 50 mm

## ORDER GUIDE: SKU

COLLECTION	MODEL	FINISH	HEIGHT
DOT dot	14A	BR brass	A 34.25" / 86 cm
	14C	GR graphite	B 40.25" / 102 cm
			C 46.25" / 117 cm
			D 52.25" / 132 cm
			E 64.25" / 163 cm
			V variable
DOT	14A	BR	A = DOT14ABRA example

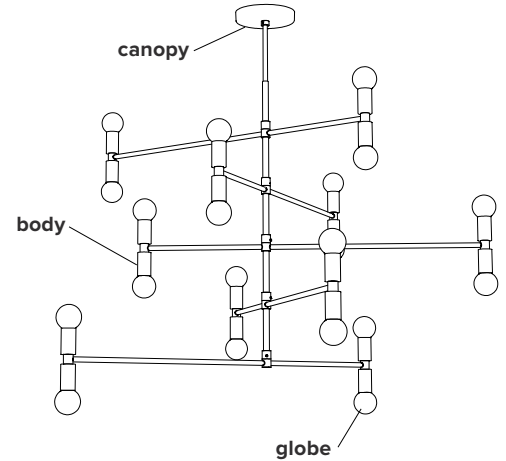

COLLECTION	MODEL	FINISH	HEIGHT
DOT dot	14B	BR brass	A 24.5" / 62 cm
		GR graphite	B 30.5" / 77 cm
			C 36.5" / 93 cm
			D 42.5" / 108 cm
			E 54.5" / 138 cm
			V variable
DOT	14B	BR	A = DOT14BBRA example

### FINISH



brass



graphite

### CANOPY

swivel option for slanted ceiling

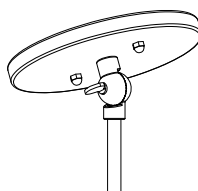

### NOTES:

- must be installed by an electrician
- not protected against liquids (refer to IP20)
- additional charges for modifications or for special orders
- please refer to maintenance sheet on website for cleaning instructions

## DIMMER SPECIFICATIONS

### DIMMER LIST COMPATIBILITY FOR G9 LED BULBS – 120V

The dimming technology offering the best results is ELV (electronic low voltage) dimmers with reverse phase or trailing edge control.

DIMMER BRAND	MODEL NUMBER	MIN LEVEL	MAX LEVEL	FLICKERING	OVERALL QUOTE
LUTRON - MAESTRO	MAELV-600	0%	100%	0%-10%	good
LUTRON - SKYLARK	SELV-300P	0%	100%	no	very good
LUTRON - SKYLARK	SELV-303P	0%	100%	no	very good
LUTRON - SKYLARK	CTELV-303P	0%	100%	no	very good
LUTRON - DIVA	DVELV-300P	0%	100%	no	very good
LEGRAND - ADORNE	TRUE UNIVERSAL	30%	100%	no	good

### DIMMER LIST COMPATIBILITY FOR G9 LED BULBS – 230V

DIMMER BRAND	MODEL NUMBER	MIN LEVEL	MAX LEVEL	FLICKERING	OVERALL QUOTE
VARILIGHT	V-PRO	2%	100%	no	very good
LEGRAND - NILOÉ	3 996 35	15%	87%	no	good
NIKO	310-0280X	5%	94%	no	very good
NIKO	310-0190X	1%	100%	no	very good

\*Other dimmers can yield good results and we recommend conducting your own test before final installation.

## EU ENERGY LABEL

